



1. Abstract

Our project is based on the idea of being able to monitor the air quality of any place with a simple cost effective kit. In the market there are lots of options at high prices with questionable reliability. Our intention is to give a step by step breakdown of how with an Arduino kit anyone is able to build their own air monitor. The importance of this project relies on two things: using accessible materials and learning how to program those materials to access the data and have a visual representation. At the heart of our project is the utilization of the **ESP-32** micro-controller which WiFi capabilities allows the user to send and store information online. Furthermore, by integrating different online services such as **Node-Red** and **Grafana**, anyone can have instant access to the information stored for further analysis and/or comparison.

2. Introduction

We are susceptible to environmental elements that can have harmful effects on our health. One of the most important factors to consider is the quality of the air we breathe, unfortunately most of us are not conscious of what is in the air and how through time the elements in the air we consume change. For that reason we have developed a tool that allows anyone with an Arduino Kit and comprehensive, but easy to follow coding to collect, send and represent data describing the air quality through time of the place where the station is placed.

The exposure to harmful air elements is of great importance for governments around the world, and many laws have been enacted to protect people at work and at the places where they live in order to reduce the exposure to harmful elements, however a lot can still be done and people need to be aware of the environment surrounding them. According to the World Health Organization, 3.2 million deaths occur every year around the world due to exposure at home to smoke from dirty cookstoves and fuels and is estimated that 4.2 million deaths a year are due to exposure to outside air pollution. Finally "9 out of 10 people worldwide live in places where air quality exceeds **WHO** guideline limits".¹⁾ While housing codes requires the installation of Carbon Monoxide and Smoke detectors, they only alert when thresholds are exceeded, but we are not able to see how through the day or

months those values are changing, additionally there is a strong correlation between air quality and the proximity to busy street intersections or industrial complexes, that is where the air quality device would inform the user of the status of the air they consume, and with time the data gathered has the potential to give out important information about the status of the environment.

A few key indicators provide most of the data necessary to assess the quality of air. Due to industrial processes and the burning of fossil fuels for energy production we can anticipate some of the most frequent gas components that can cause harm. The Arduino Kit in combination with the **ESP-32** micro-controller and adaptable sensors are able to “read” the quality of the air and translate it into data that we can see and understand. The microcontroller is able to process the data and transmit it over Wifi, where online tools like **Grafana** are able to visually represent the data of any required period of time to produce graphs that are very informative.

The device is made as a reliable indicator of possible common harmful elements in the air, its portability and connectivity allows for its use in almost any setting and most importantly the low cost of making it combined with easy to follow instructions, makes it an accessible tool that anyone can invest into.

Key device features used for this project are: Connectivity, Portability and Data Management .

3. Method

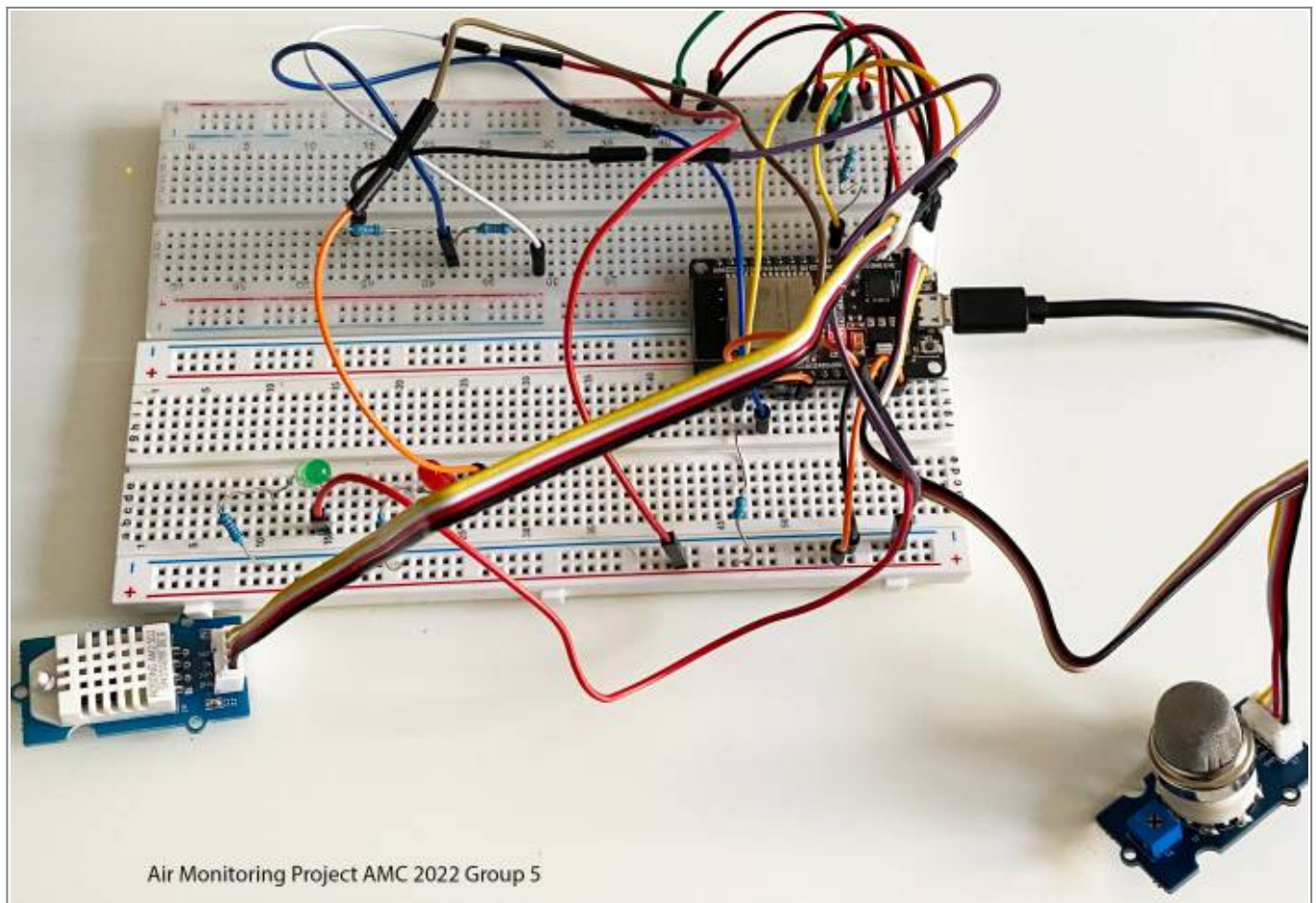

figure 1 Setup showing the connections of sensors to ESP32

3.1 Temperature and Humidity Measurement

The DHT-22 sensor is a dual system peripheral that is able to measure temperature and humidity. Its use has many applications in different settings. Due to its easy operation and low cost, a wide range of projects rely on the sensor to get accurate readings. From terrariums to weather stations and automated climate control systems, the usability of the sensor proves to be a great tool. In determining Air quality it is very important to measure both temperature and humidity, since it has direct effects on the health of a person. Knowing those 2 factors can help the user get an overall picture of the environment surrounding her or him.

For our purposes we initiated this project with the DHT-22 sensor because it was simple to install and program, but we also believe that for any upgrading of the system or expansion to a more complicated set-up in the field of ambiental measuring, the temperature and humidity are a must. Additionally the ability to save the data collected and to be represented in Grafana allows the user to have a better understanding of things that could be done in order to improve the Air quality of the room or apartment, for instance the user can see in detail how closing the curtains on hot summer days can help maintain the space cooler, or how high humidity in closed spaces can have negative consequences such as the proliferation of mold which both causes damages to the property and has negative health risks. A great place to have the Air Quality station would be a basement or an attic, where lack of moving air tends to create a setting where polluting particles and gasses can accumulate without the owner or user of the space being aware.

How we implemented the DHT-22 sensor into our device is described [here](#).

3.2 Air Particles Measurement

3.3 MQTT Database and WiFi Connection

To start we use the ESP-32 micro-controller that has very important features, WiFi capabilities to transmit information digitally over any network connection which almost everyone has access to in their houses or workplaces. Additionally, one can connect the controller to a Mobile Hotspot if doing field air quality assessment where no WiFi is available but there is cell phone connection.

MQTT is a client-server publish/subscribe messaging transfer protocol. It uses the TCP/IP protocols to interconnect network devices to the internet. MQTT connects the Client to the server and provides the means to send an ordered, lossless, stream of bytes in both directions. MQTT Broker is computer software, which enables MQTT clients to communicate. MQTT brokers receive the messages published by clients, filter the message topics, and distribute them to subscribers. A client establishes the network connection to the server by:

- Publishing messages to other clients
- subscribing to request messages
- can unsubscribe and disconnect from the server

A server acts like an intermediary between the publishers and subscribers. A server accepts network connections from clients and messages published by the clients. A server also processes the subscribe and unsubscribe requests from clients. Furthermore, a subscription is comprised of a topic filter and maximum Qos. Each subscription within a session has a different Topic filter. Before data/message is published, a topic name is required. The topic name must match against the

subscription known to the server. The message is sent to each client that has that matching topic name. In this project, an MQTT Broker called MQTTX was used to transmit data from the sensors below, where the data was then stored in a data base (influxdb) and then visualised using Grafana as shown on figure 2 and 3 below.

MQTTX

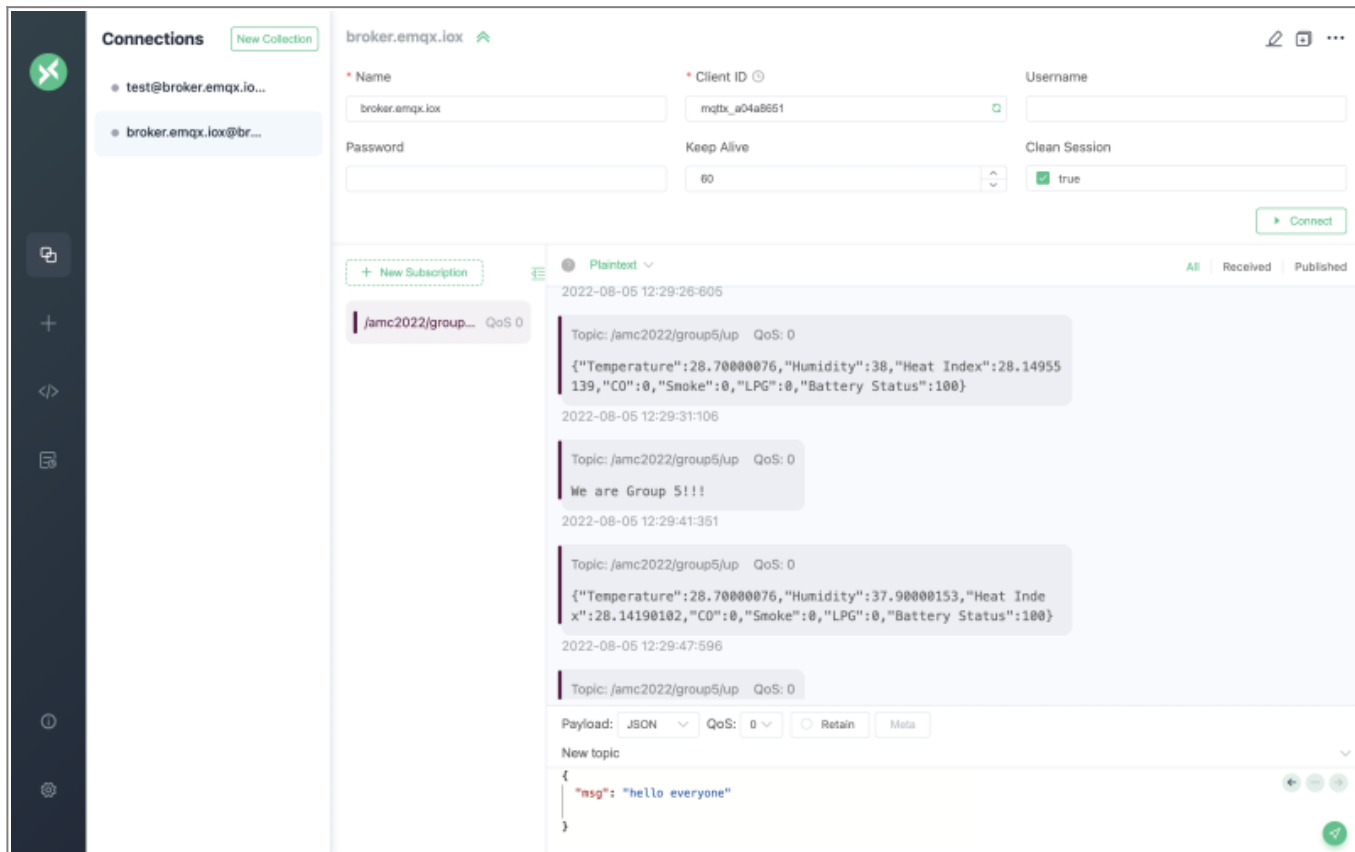

figure 2 Publish and subscription on MQTTX

Node Red

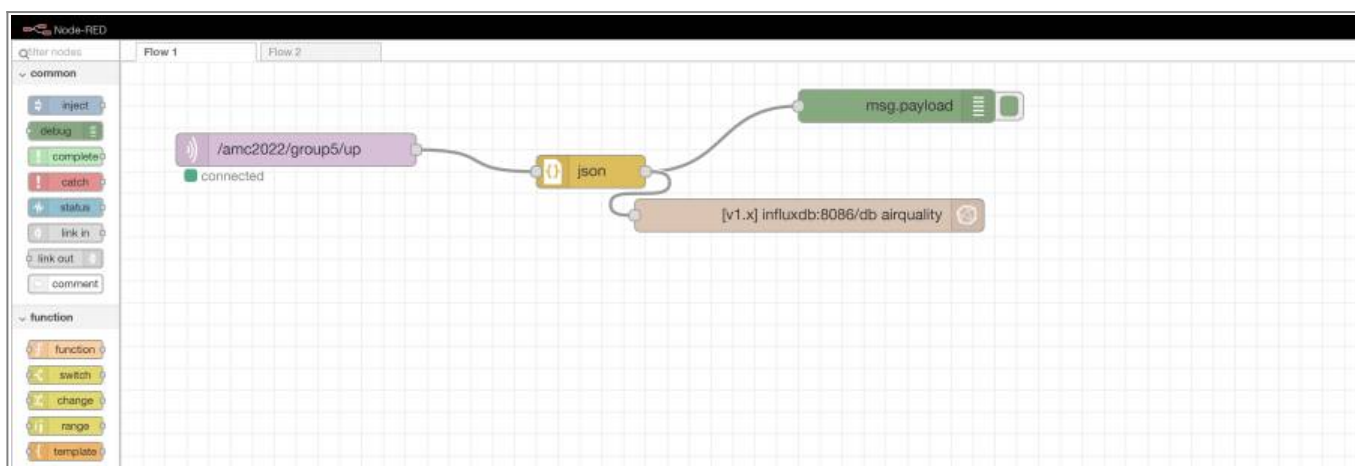

Figure 3 setup on node-red showing data from mqtt being stored in a data base (influxdb)

code and explanation

Wifi Connection

In order to connect ESP32 to the MQTT Broker, the ESP32 must be connected to the internet. Since ESP32 supports wifi, it could easily be connected to the local wifi by writing some lines of code on the Arduino IDE.

3.4 Battery Voltage Measurement

Since our device is powered by a battery for portability, it is important for us to know the status of the battery. To measure the battery's voltage we can use a multimeter, but we want to integrate the capabilities of the microcontroller to read voltages through its Analog to Digital Converter (ADC) pins. Not only is this a more efficient approach by reducing costs but it can also help us access the information online, where we are able to not only check the status of the battery in **Grafana**, but we would also know when to replace it or even make changes to the sensors or code to improve performance. The setup is done with the concept of creating a voltage divider. This is achieved by creating a circuit within a bigger circuit and obtaining a reduced voltage with the introduction of resistors connected in series. As shown in Figure #.



Figure 4 Source:

<https://www.electroniclinic.com/what-is-a-voltage-divider-or-potential-divider-formula-and-practical-uses/>

Why we would lower the voltage is due to the micro-controllers specifications. The input voltage cannot exceed 3.3V, otherwise we would risk damaging the controller. ESP-32 analog channels are of 12 bit which means the minimum step of each voltage level is between 0 and 4095 or 2^{12} . Analog channel produces a digital value between 0 and 4095 according to the voltage at the input of the analog channel²⁾, therefore:



- If the voltage is 0 at the input of the analog channel, the digital value will be zero.
- If the voltage is 3.3 volt at the input, the digital value will be 4095. So the maximum voltage limit is 3.3 volt.

Because the battery used is 9V, we want to make sure that the ADC pin only receives up to 3.3V. Knowing both the Voltage source, the Output Voltage and one of the resistor values, we can then find the other resistor that would complete our circuit by using the Voltage/Potential Divider equation of Figure 4. There are plenty of websites that have very easy to follow tools to find any of the values of

our equation. For our purposes we used <https://ohmslawcalculator.com/voltage-divider-calculator>. Alternatively by knowing the resistors used we can calculate the output voltage. Since we are using the hardware provided in the ELEGOO KIT, we have decided to use one 10k Ohms and one 5k Ohms resistors connected in series, which provide us with an output voltage of 3V.

Description and Results can be found on this link.

3.5 Deep Sleep Mode and Power Saving

The use of a battery for power supply has a drawback, limited amount of energy available. With the integration of the sensors and the continuous use of the microcontroller the battery life would last a very short period of time, therefore certain measurements have to be placed in order to limit power consumption and expand the battery life. ESP-32 has Sleep Modes, which are power consumption settings that limit the use of peripherals and components until the device is awakened again. This setting is very important in that the user can select what components of the micro-controller are to stay active depending on the necessity of the project. For ESP-32 the following power modes are available:

- Active
- Modem-Sleep
- Light-Sleep
- Hibernation
- Deep-Sleep

The specifications for the power consumption of each of the Sleep modes can be found on this datasheet.

For the purposes of this project we have selected Deep-Sleep mode. In it only the Real Time Clock (RTC) module, which keeps track of time and date in the absence of an external power supply, and the Ultra-Light Co-processor (ULP) module which purpose is to perform readings through the ADC and I2C pins, remain active while the main processor is in Deep-Sleep mode as shown in Figure 5.

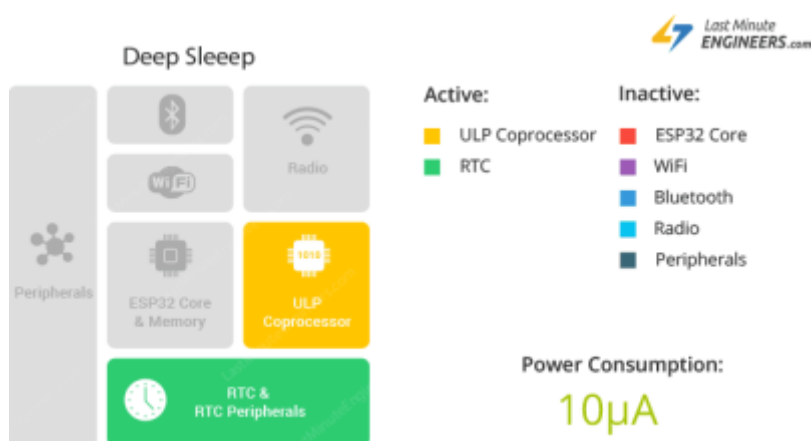

Figure 5 ESP-32 Active Components during Deep Sleep mode. Source: <https://lastminuteengineers.com/esp32-sleep-modes-power-consumption/>

Deep Sleep mode allows us to perform the following tasks:

1. Only use the device on a specified interval, since we only want to measure the Air Quality of the

ambient every # minutes.

2. While not in use, conserve as much power as possible.
3. Keep RTC clock active to set up the alarm that will turn on the device and sensors.
4. Have an external pin that can be used to wake up the system on command.

Complete description of the set-up procedure can be found [here](#).

4. Materials



1. ESP 32
2. MQ2
3. DHT22 HUMIDITY & TEMPERATURE SENSOR

5 Codes and explanation

```

/*****
 * AMC group 5 2022
 * Monitoring air quality.
 */

/*****ESP32 wifi
connect*****
*****/

#include <WiFi.h>                                     /*wifi
library*/
#include <PubSubClient.h>                             /*library that
allows you to subscribe and publish mqtt messages*/
const char *ssid = "";                               /*wifi network
name*/
const char *password = "";                           /*WiFi
password*/

/*****MQTT
Broker*****
*****/

*Several topics can be created for each sensor
*connecting to a host and a server
*/

const char *mqtt_broker = "broker.emqx.io";          /*mqtt
broker/server*/
const char *topic_up = "/amc2022/group5/up";        /* topic

```

```

name*/
//const char *topic_DHT22 = "/amc2022/group5/DHT22";
//const char *topic_MQ2 = "/amc2022/group5/MQ2"
const char *topic_down = "/amc2022/group5/down";
const char *mqtt_username = ""; /*add
username if needed*/
const char *mqtt_password = ""; /*add
password if needed*/
const int mqtt_port = 1883; /*mqtt
port*/

/*****Temperature and Humidity
DHT22*****
*****/

#include <DHT.h> /*importing
library for DHT sensors*/
#include <DHT_U.h>
#define DHTPIN 4 /*connect DHT22
to pin 4 of the esp32*/
#define DHTTYPE DHT22
DHT dht(DHTPIN, DHTTYPE); /*calling dht
pin, and dht sensor type from imported libraries*/

/*****INSTANTIATING A CLIENT TO CONNECT TO THE
SERVER*****/
WiFiClient espClient; /*client class: creates a client that can
connect to a specified internet IP address and port.*/
PubSubClient client(espClient); /* creating partially initialized client
instance*/

/*****Message*****
*****/

long lastMsg = 0;
char msg[80]; /* Message buffer size*/
int value = 0;

/*****JSON*****
*****/

#include <ArduinoJson.h>
DynamicJsonDocument doc(1024); /*allocating memory
pool(for storing data)*/

```

```

/***** Deep sleep for power
saving*****/
*****/

#define uS_TO_S_FACTOR 1000000          /* Conversion factor
for micro seconds to seconds */
#define TIME_TO_SLEEP  600             /* Time ESP32 will go
to sleep (in seconds) */

RTC_DATA_ATTR int bootCount = 0;

int GREEN_LED_PIN = 33;
int RED_LED_PIN = 32;

/*****Defining Battery status
*****/

#define ADC_PIN 34                      /*battery pin on esp32*/
#define BATT_MAX 5                       /*Maximum voltage from power source*/
#define BATT_MIN 3.2                    /*minimum voltage*/
#define BATT_LOW 3.4                    /*indicates low, battery needs to be
recharged/ changed*/

/*****Globals for battery
status*****/
*****/

int pinreading;                        /*define pin on esp32 board*/
float bat_voltage;                      /*define battery voltage*/
int batt_percentage;                   /*define battery percentage*/

/*****defining
mq2sensor*****/
*****/

/*****defining other Hardware Related
Macros*****/

#define MQ2PIN 36                       //define which
analog input channel you are going to use
#define RL_VALUE_MQ2 1                   //define the load
resistance on the board, in kilo ohms
#define RO_CLEAN_AIR_FACTOR_MQ2 9.577

```

```

//RO_CLEAR_AIR_FACTOR=(Sensor resistance in clean air)/R0,
//which is derived
from the chart in datasheet

/*****Defining Software Related Macros for
mq2*****/

#define CALIBARAION_SAMPLE_TIMES (50) //define how many
samples you are going to take in the calibration phase
#define CALIBRATION_SAMPLE_INTERVAL (500) //define the time
interval(in 500 millisecond) between each samples in the
//calibration phase
#define READ_SAMPLE_INTERVAL (50) //define how many
samples you are going to take in normal operation
#define READ_SAMPLE_TIMES (5) //define the time
interval(in millisecond) between each samples in
//normal operation

/*****defining Application Related Macros for
mq2*****/

#define GAS_HYDROGEN (0)
#define GAS_LPG (1)
#define GAS_METHANE (2)
#define GAS CARBON MONOXIDE (3)
#define GAS_ALCOHOL (4)
#define GAS_SMOKE (5)
#define GAS_PROPANE (6)
#define accuracy (0) //for linearcurves
#define accuracy (1) //for nonlinearcurves,
un comment this line and comment the above line if
\\ calculations
//are to be done using
non linear curve equations

/*****Globals for
mq2*****/

float Ro = 0; //Ro is initialized to 10
kilo ohms

void setup() {
  Serial.begin(9600); //sets data in bits per
second(baud) for serial data transmission*/

  dht.begin(); //start dht22 sensor*/

```

```

/*****CONNECTING
WIFI*****
*****/

WiFi.begin(ssid, password);
while (WiFi.status() != WL_CONNECTED) {
  delay(500);
  Serial.println("Connecting to WiFi..");          /*prints on
serial board*/
}
Serial.println("Connected to the WiFi network");

/**** Connecting to a mqtt
broker*****
*****/

client.setServer(mqtt_broker, mqtt_port);          /*setting mqtt
server*/
client.setCallback(callback);                      /*calls function
in response to an event. */

while (!client.connected()) {
  String client_id = "esp32-client-";
  client_id += String(WiFi.macAddress());
  Serial.printf("The client %s connecting to the public mqtt broker\n",
client_id.c_str());
  if (client.connect(client_id.c_str(), mqtt_username, mqtt_password)) {
    Serial.println("Public emqx mqtt broker connected"); /*connecting
client*/
  } else {
    Serial.print("failed with state ");
    Serial.print(client.state());
    delay(2000);
  }
}

/***** Publish and
subscribe*****
*****/

client.publish(topic_up, "We are Group 5!!!");     /*publishes to mqtt*/
client.subscribe(topic_down);                      /*topic for
subscription*/

delay(2000);                                       /*wait for 2s*/

```

```

/*****READING BATTERY
STATUS*****/
*****/
/*****calculating battery
voltage*****/
*****/

pinreading = analogRead(ADC_PIN);
bat_voltage = ((float)analogRead(ADC_PIN) / 4095) * 3.3 * 2.2;
/*The equation is calibrated for accuracy*/
Serial.print("value from pin:");

Serial.print(pinreading);

Serial.println("voltage:");
Serial.print(bat_voltage);

/*****Calculating battery
percentage*****/
*****/

batt_percentage = (uint8_t)((((bat_voltage - BATT_MIN) / (BATT_MAX -
BATT_MIN)) * 100); /*Equation of percentage based on V*/

if (batt_percentage > 100) {

    batt_percentage = 100;
}
if ( batt_percentage <= 0) {

    batt_percentage = 0;
}
Serial.println("battery percentage:");
Serial.print(batt_percentage);

/*****MQ2 calibration and reading of
data*****/

Serial.print("Calibrating...\n");
Ro = MQCalibration(MQ2PIN); //Calibrating the
sensor. Please make sure the sensor is in clean air
//when you perform the calibration
Serial.print("Calibration is done...\n");
Serial.print("Ro=");
Serial.print(Ro);

```

```

Serial.print("kohm");
Serial.print("\n");

Serial.print("HYDROGEN:");
Serial.print(MQGetGasPercentage(MQRead(MQ2PIN) / Ro, GAS_HYDROGEN) );
Serial.print(" ppm" );
Serial.print(" ");
Serial.print("LPG:");
Serial.print(MQGetGasPercentage(MQRead(MQ2PIN) / Ro, GAS_LPG) );
Serial.print(" ppm" );
Serial.print(" ");
Serial.print("METHANE:");
Serial.print(MQGetGasPercentage(MQRead(MQ2PIN) / Ro, GAS_METHANE) );
Serial.print(" ppm" );
Serial.print(" ");
Serial.print("CARBON_MONOXIDE:");
Serial.print(MQGetGasPercentage(MQRead(MQ2PIN) / Ro, GAS_CARBON_MONOXIDE)
);
Serial.print(" ppm" );
Serial.print(" ");
Serial.print("ALCOHOL:");
Serial.print(MQGetGasPercentage(MQRead(MQ2PIN) / Ro, GAS_ALCOHOL) );
Serial.print(" ppm" );
Serial.print(" ");
Serial.print("SMOKE:");
Serial.print(MQGetGasPercentage(MQRead(MQ2PIN) / Ro, GAS_SMOKE) );
Serial.print(" ppm" );
Serial.print(" ");
Serial.print("PROPANE:");
Serial.print(MQGetGasPercentage(MQRead(MQ2PIN) / Ro, GAS_PROPANE) );
Serial.print(" ppm" );
Serial.print("\n");
delay(200);

/**** Reading temperature or
humidity*****/
*****/

float h = dht.readHumidity(); // Read
temperature as Celsius (the default)

float t = dht.readTemperature(); // Read
temperature as Fahrenheit (isFahrenheit = true)

float f = dht.readTemperature(true); // Read
temperature as Fahrenheit (isFahrenheit = true)

if (isnan(h) || isnan(t) || isnan(f)) {
  Serial.println(F("Failed to read from DHT sensor!")); // Check if any

```

```
reads failed and exit early (to try again).
    return;
}

float hif = dht.computeHeatIndex(f, h);           // Compute heat
index in Fahrenheit (the default)

float hic = dht.computeHeatIndex(t, h, false);    // Compute heat
index in Celsius (isFahreheit = false)

Serial.print(F("Humidity: "));
Serial.print(h);
Serial.print(F("% Temperature: "));
Serial.print(t);
Serial.print(F("°C "));
Serial.print(f);
Serial.print(F("°F Heat index: "));
Serial.print(hic);
Serial.print(F("°C "));
Serial.print(hif);
Serial.println(F("°F"));

client.loop();

/*****Publish message on MQTT as JSON
*****
***/

long now = millis();
if ((now - lastMsg) > 5000) {
    lastMsg = now;

    doc["Temperature"] = t;
    doc["Humidity"] = h;
    doc["Heat Index"] = hic;
    doc["CO"] = MQGetGasPercentage(MQRead(MQ2PIN) / Ro,
GAS_CARBON_MONOXIDE);
    doc["Hydrogen"] = MQGetGasPercentage(MQRead(MQ2PIN) / Ro, GAS_HYDROGEN)
;
    doc["Smoke"] = MQGetGasPercentage(MQRead(MQ2PIN) / Ro, GAS_SMOKE);
    doc["LPG"] = MQGetGasPercentage(MQRead(MQ2PIN) / Ro, GAS_LPG);
    doc["Methane"] = MQGetGasPercentage(MQRead(MQ2PIN) / Ro, GAS_METHANE);
    doc["Propane"] = MQGetGasPercentage(MQRead(MQ2PIN) / Ro, GAS_PROPANE);
    doc["Alcohol"] = MQGetGasPercentage(MQRead(MQ2PIN) / Ro, GAS_ALCOHOL);
    doc["Battery Status"] = batt_percentage;

/*****/
```

```

/*****CONVERTING JSON OBJECT TO
BUFFER*****/
*****/

    byte buffer[256];                //Predefined
number//
    size_t n = serializeJson(doc, buffer);    //Collects the
data and converts into JSON
    client.publish(topic_up, buffer, n, false);

    Serial.println("Published!");        //Publishes data
in JSON form to be accessed online

/*****DEEP SLEEP FOR POWER
SAVING*****/
/

    pinMode(GREEN_LED_PIN, OUTPUT);
    pinMode(RED_LED_PIN, OUTPUT);
    delay(500);

    if (bootCount == 0) /*Red light blinks only for the first reading while
green light blinks for all other readings*/
    {
        digitalWrite(RED_LED_PIN, HIGH);
        bootCount = bootCount + 1;
    } else
    {
        digitalWrite(GREEN_LED_PIN, HIGH);
    }

    delay(3000);

    digitalWrite(GREEN_LED_PIN, LOW);
    digitalWrite(RED_LED_PIN, LOW);

/*****Wake and sleep
esp32*****/
*****/

    esp_sleep_enable_timer_wakeup(TIME_TO_SLEEP * uS_TO_S_FACTOR);
    esp_deep_sleep_start();
}

```

```
}

/*****CALLBACK
FUNCTION*****/
*****/

/***** The mqtt client calls a callback method on seperate thread to main
application thread.*****/

void callback(char *topic, byte *payload, unsigned int length) {
  Serial.print("Message arrived in topic: ");
  Serial.println(topic);
  Serial.print("Message:");
  for (int i = 0; i < length; i++) {
    Serial.print((char) payload[i]);
  }
  Serial.println();
  Serial.println("-----");
}

void loop() {
  /*left blank, to save battery. Since
after each reading, the esp32 restarts*/
}

/***** MQ2 Resistance Calculation
*****/

  Input: raw_adc - raw value read from adc, which represents the voltage
  Output: the calculated sensor resistance
  Remarks: The sensor and the load resistor forms a voltage divider. Given
the voltage
          across the load resistor and its resistance, the resistance of the
sensor
          could be derived.

*****/

float MQResistanceCalculation(int raw_adc)
{
  return ( ((float)RL_VALUE_MQ2 * (1023 - raw_adc) / raw_adc));
}
```

```

/***** MQCalibration *****/
*****

Input:  mq_pin - analog channel
Output: Ro of the sensor
Remarks: This function assumes that the sensor is in clean air. It use
MQResistanceCalculation to calculates the sensor resistance in
clean air
and then divides it with RO_CLEAN_AIR_FACTOR. RO_CLEAN_AIR_FACTOR
is about
10, which differs slightly between different sensors.

*****
*****/

float MQCalibration(int mq_pin)
{
  int i;
  float RS_AIR_val = 0, r0;

  for (i = 0; i < CALIBARAION_SAMPLE_TIMES; i++) { //take
multiple samples
    RS_AIR_val += MQResistanceCalculation(analogRead(mq_pin));
    delay(CALIBRATION_SAMPLE_INTERVAL);
  }
  RS_AIR_val = RS_AIR_val / CALIBARAION_SAMPLE_TIMES; //calculate
the average value

  r0 = RS_AIR_val / RO_CLEAN_AIR_FACTOR_MQ2;
//RS_AIR_val divided by RO_CLEAN_AIR_FACTOR yields the Ro
//according
to the chart in the datasheet

  return r0;
}

/***** MQRead *****/
*****
*****/

Input:  mq_pin - analog channel
Output: Rs of the sensor
Remarks: This function use MQResistanceCalculation to caculate the sensor
resistenc (Rs).
The Rs changes as the sensor is in the different consentration of
the target
gas. The sample times and the time interval between samples could
be configured
by changing the definition of the macros.

/*****
*****/

```

```

*****/

float MQRead(int mq_pin)
{
  int i;
  float rs = 0;

  for (i = 0; i < READ_SAMPLE_TIMES; i++) {
    rs += MQResistanceCalculation(analogRead(mq_pin));
    delay(READ_SAMPLE_INTERVAL);
  }

  rs = rs / READ_SAMPLE_TIMES;

  return rs;
}

/***** MQ Get Gas Percentage *****/
*****/

Input:  rs_ro_ratio - Rs divided by Ro
        gas_id      - target gas type
Output: ppm of the target gas
Remarks: This function uses different equations representing curves of
each gas to
        calculate the ppm (parts per million) of the target gas.
/***** *****/
*****/

/*****Calculations*****/
*****/

int MQGetGasPercentage(float rs_ro_ratio, int gas_id)
{
  if ( accuracy == 0 ) {
    if ( gas_id == GAS_HYDROGEN ) {
      return (pow(10, (((log10(rs_ro_ratio)-1.41)) / (-0.47))));
//Numbers obtained from the Table 1 on MQ2 page
    } else if ( gas_id == GAS_LPG ) {
      return (pow(10, (((log10(rs_ro_ratio)-1.425)) / (-0.45))));
    } else if ( gas_id == GAS_METHANE ) {
      return (pow(10, (((log10(rs_ro_ratio)-1.34)) / (-0.37))));
    } else if ( gas_id == GAS_CARBON_MONOXIDE ) {
      return (pow(10, (((log10(rs_ro_ratio)-1.51)) / (-0.34))));
    } else if ( gas_id == GAS_ALCOHOL ) {
      return (pow(10, (((log10(rs_ro_ratio)-1.31)) / (-0.37))));
    } else if ( gas_id == GAS_SMOKE ) {
      return (pow(10, (((log10(rs_ro_ratio)-1.61)) / (-0.44))));
    } else if ( gas_id == GAS_PROPANE ) {

```

```
    return (pow(10, (((log10(rs_ro_ratio)-1.29)) / (-0.46))));
  }
}

else if ( accuracy == 1 ) {
  if ( gas_id == GAS_HYDROGEN ) {
    return (pow(10, (((log10(rs_ro_ratio)-1.41)) / (-0.47))));
//Numbers obtained from Table 1 on MQ2 description
  } else if ( gas_id == GAS_LPG ) {
    return (pow(10, (((log10(rs_ro_ratio)-1.425)) / (-0.45))));
  } else if ( gas_id == GAS_METHANE ) {
    return (pow(10, (((log10(rs_ro_ratio)-1.34)) / (-0.37))));
  } else if ( gas_id == GAS_CARBON_MONOXIDE ) {
    return (pow(10, (((log10(rs_ro_ratio)-1.51)) / (-0.34))));
  } else if ( gas_id == GAS_ALCOHOL ) {
    return (pow(10, (((log10(rs_ro_ratio)-1.31)) / (-0.37))));
  } else if ( gas_id == GAS_SMOKE ) {
    return (pow(10, (((log10(rs_ro_ratio)-1.61)) / (-0.44))));
  } else if ( gas_id == GAS_PROPANE ) {
    return (pow(10, (((log10(rs_ro_ratio)-1.29)) / (-0.46))));
  }
}
return 0;
}
```

6. Results

Serialboard

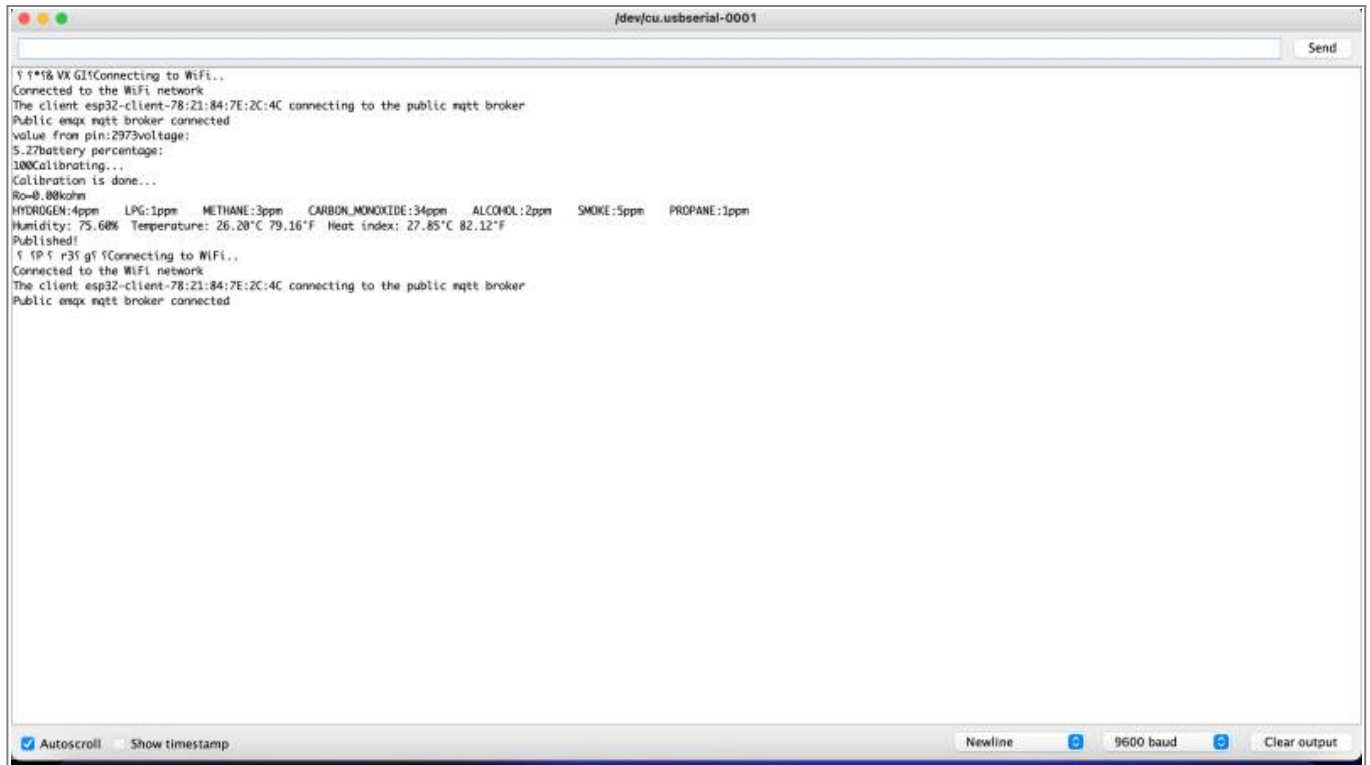

figure #

Grafana

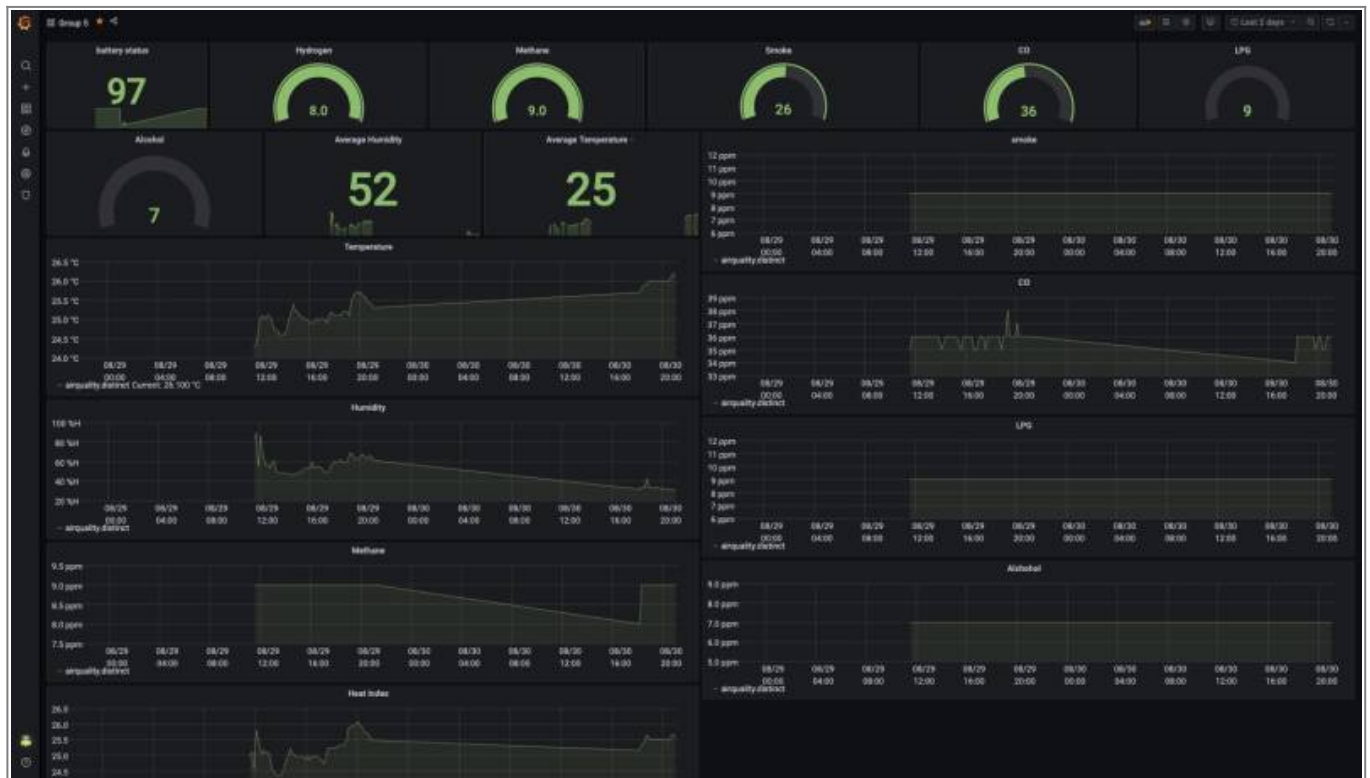

figure # Measurement result of DHT22 and MQ2 sensors visualised on grafana

7. Conclusion

8. Discussion

For discussion we want to talk about two things, one is how we can improve our device and the second is what issues are presented during the current set-up and how it affects its performance.

To start we are going to look at the current issues. Due to the idea of having a system that is easy to set up and needs as little investment as possible, we have opted for the exclusion of parts that could in the future aid in the performance of the device for both battery consumption and accuracy in the data registered. The main issue comes from the utilization of the 9V battery provided in the ELEGOO kit. That specific battery doesn't hold a large charge. For the 6F22 which is the model of our battery, meaning that is based on Zinc-Carbon material, the average capacity is limited to about 400mAh. Additionally they are not suitable for recharging and the efficiency and durability is highly influenced by ambient temperature. Moreover, because the voltage is higher than the required by the ESP-32 microcontroller, it means that we can either use the internal resistor of the microcontroller or an external linear regulator or a switcher, however for any of these options there is going to be loss of energy in the form of heat produced by the resistance. What we would like is to have a rechargeable battery that holds more power and is set up to provide 3.3 to 3.7V. In addition the inclusion of a PV module, which will recharge the battery, however still the main purpose of the device is to measure the air quality of enclosed spaces, therefore consideration must be put into the installation and placement of the PV module, and whether it makes sense to use it or not. High quality sensors are available that can not only measure specific compounds but will yield better results. One which would be good to add to our device would be the MQ-131 Ozone sensor. Ozone is produced by multiple household products, such as steamers, air purifiers and ultraviolet lamps. The indication of high levels of Ozone in a confined space could cause a health hazard for anyone within that space. The price of the sensor is \$38 on amazon.com. That highly elevates the overall cost of the project and was deemed not suitable.

Issues with the current set-up are based on the components and its limitations. For example the MQ-2 sensor needs to be active and heat up for a period of 24 hours before the reading to increase its accuracy. Due to its requirements, power consumption is increased. Additionally, the calibration of the device is undefined, meaning that it can be adjusted individually to meet specific requirements. The use of RTC memory to reduce WiFi connections is an option that has two effects. One is the reduction of power consumption due to the sending of information in bulk packages and the other is the inability to obtain information due to the lapse time between connections. RTC memory is used to store information during Deep Sleep mode. Since the main memory of the microcontroller is wiped when it goes to sleep, the sensors can instead take the readings and the data is stored on the RTC without the need of doing one reading followed by one WiFi transmission. For example if we set up the device to do 10 readings per hour, instead of connecting the device to the WiFi 10 times to transmit the data, it can instead connect only once every hour and send the 10 readings in one package. That would considerably reduce the power consumption, however, if as in the previous example we would have the opportunity of having more up to date information, every 10 minutes of the Air Quality, alternatively we would have to wait an hour to know what were the readings during that time. Since we opted for a system that gives you the latest information we avoided using RTC memory.

9. Video Explanation

[amc_lq_group_5.mp4](#)

10. References

Measuring the Temperature, Humidity, smoke, Carbon Monoxide(CO), and Liquefied petroleum gas(LPG) in the air.

Bogdan, Mihai. (2016). How to Use the DHT22 Sensor for Measuring Temperature and Humidity with the Arduino Board. ACTA Universitatis Cibiniensis. 68. 10.1515/aucts-2016-0005.

1)

World Health Organization. https://www.who.int/health-topics/air-pollution#tab=tab_1

2)

<https://microcontrollerslab.com/adc-esp32-measuring-voltage-example/>

From:

<https://wiki.eolab.de/> - **HSRW EOLab Wiki**

Permanent link:

<https://wiki.eolab.de/doku.php?id=amc2022:grouph:start&rev=1662736344>

Last update: **2022/09/09 17:12**

